

Stage of life  
**wineo**<sup>®</sup>

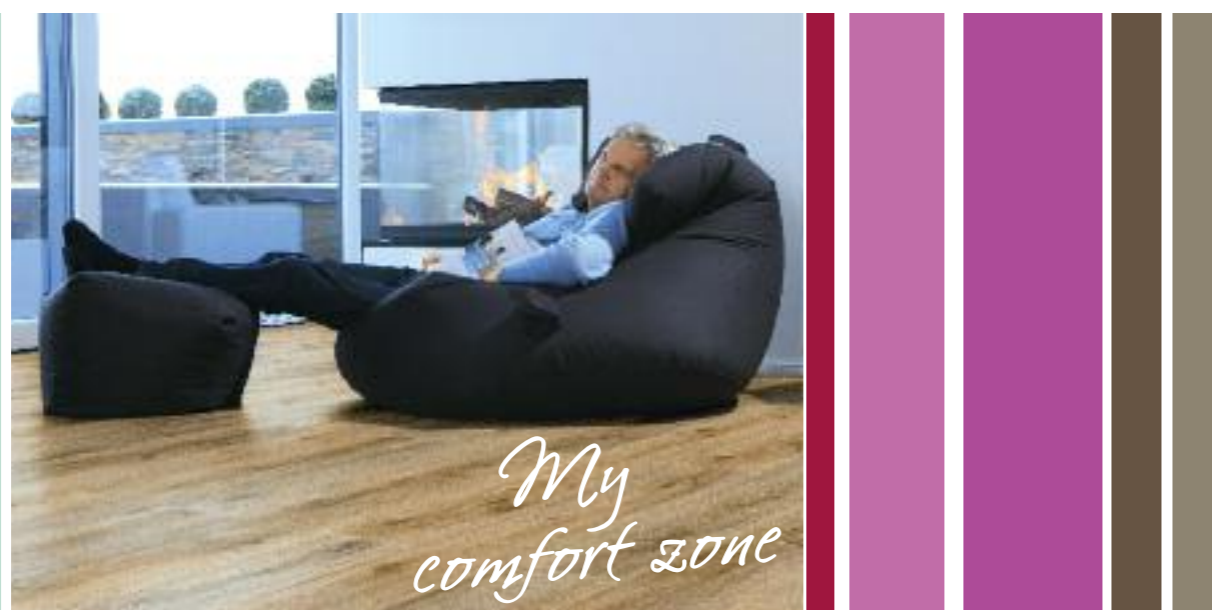

**bonita** 8

**euro** 16

**marena** 22

**ariosa** 36

**piazza** 40

**color** 46

Accessories 52

Service 60

Collection overview 63

**WITEX**<sup>®</sup>  
*inside*  
 LAMINATE

LAMINATE

# LAMINATE THE WHYS AND WHEREFORES

Innovative solutions for the floor. We have stayed true to this guiding principle with our products for over 30 years.

As one of the first manufacturers in Germany under the Witex brand, we started producing laminate flooring in 1991. Through many innovations and product optimisations up to today, we have helped to shape the development of laminate flooring into a multifaceted, quality product.

With the quality products in this catalogue, we show you a wide range of attractive decors as well as designer surfaces in the laminate flooring field, which meet all the requirements of modern living and furnishing, both in the residential and commercial sector. Divided into the bonita, euro, marena, piazza, ariosa and color collections, you will find the right thing for every taste and furnishing style.

With its excellent properties in terms of use, you will always make the right choice with a laminate floor from the wineo brand. Whether you are looking for a product suitable for chair castors or underfloor heating, with non-staining quality or optimized room acoustics. With the wineo product range we can offer you the right solution.

At the same time, we also pay particular attention the conservation of natural resources. As a manufacturer of products that are made of up to 90 percent wood, sustainability is a particular obligation for us.



This not only requires environmentally friendly manufacture but also covers ecologically sound waste disposal at the end of the product life cycle.

Windmüller stands for a conservational approach to natural resources with its products and innovations. Besides dealing with raw materials in a responsible manner, the focus is also on environmentally friendly production.



wineo laminate floors are long-lasting and durable products, whose coreboards are made of high density wood fibreboards. As wood is one of our renewable raw materials, wineo laminate flooring counts as an ecological product. Windmüller only uses raw materials like wood from sustainable forestry and never exotic timbers or wood from rain forests.

During the production of laminate floors in our factories, environmental protection is at the forefront. What starts with energy management is consistently continued when it comes to using sawmill waste, as this is used to generate process heat.

With a wineo laminate floor, you always make the right choice. Whether for the kitchen, bedroom, study, living room, hallway, children's room, loft, basement ... always the best choice.



# THE WINEO QUALITY A CARE-FREE PRODUCT



All products made by Windmüller have one thing in common: they are produced according to the strictest quality criteria! What begins with the careful selection of our raw material suppliers, continues in each separate production step. A State-of-the-art logistics with a just-in-time delivery service and an expert service team focus on a single goal: The highest level of customer satisfaction!

You will find a collection of technical innovations in our wineo laminate floors. Many ideas and patents in this field have been developed and improved by Windmüller engineers. The result pleases craftsmen and customers alike. A floor that withstands a great deal and is easily laid. A genuine carefree product!

All wineo brand floors have optimal protection against moisture and damp. Edge protection on all sides, noticeable by the darker colour of the edges, in combination with coreboards that are protected against swelling, ensure the highest level of security. Collections with AquaProtect coreboards are even suitable for use in damp environments.

The seal on the click-in connection has two further benefits. Installation is much easier. The floor panels almost *slide* into each other, and because wood is not rubbing on wood here, *creaking* planks are a thing of the past.



Depending on the product, features such as anti-static, FSC® certification, PEFC certification and V-joints belong to the repertoire of the wineo branded collections.

The wineo product range, besides featuring the classic laminate designs, also covers high gloss finishes in the color collection. Despite its high gloss finish, *color*, for example, easily achieves wear class 32. Just as *piazza* and *piazza maxi* make an ideal material for shop fitting and the contract sector.

The independently tested quality creates the framework conditions for important certifications in the construction sector for all wineo products. One of these is the building regulations approval by the German Institute for Building Technology (DIBT), plus the *CE mark* and the *sign of conformity* for externally monitored quality. Outstanding results and top marks from independent tests confirm the importance of these certificates.



# SURFACES VARIETY OF TEXTURES

The finishes on wineo laminate floors consist of up to three layers. On top there is a particularly resilient melamine resin overlay, which protects the floor from mechanical loads. The texture of the finishes varies depending on the collection and design. Besides tangible wood textures, there are soft finishes and fine wood grains, which are produced in various levels of sheen or in matt look. The second layer is a resin-coated decor paper, on which wood, tile or fantasy decors are depicted.

The *piazza* and *piazza maxi* collections feature the DPL+ system developed by Windmüller. A resin-coated reinforcing layer is pressed underneath the decor layer making the flooring particularly resilient. These floors are especially suited for use in the commercial sector and come with a 5-fold lifetime guarantee.



Fine wooden pore



Exclusive wood structure



Handscraped l



Silk matt



Matt surface



Rough sawn



Registered embossed surface



Soft surface



Tile texture



High gloss surface

# LAMINATE PRODUCT COMPOSITION

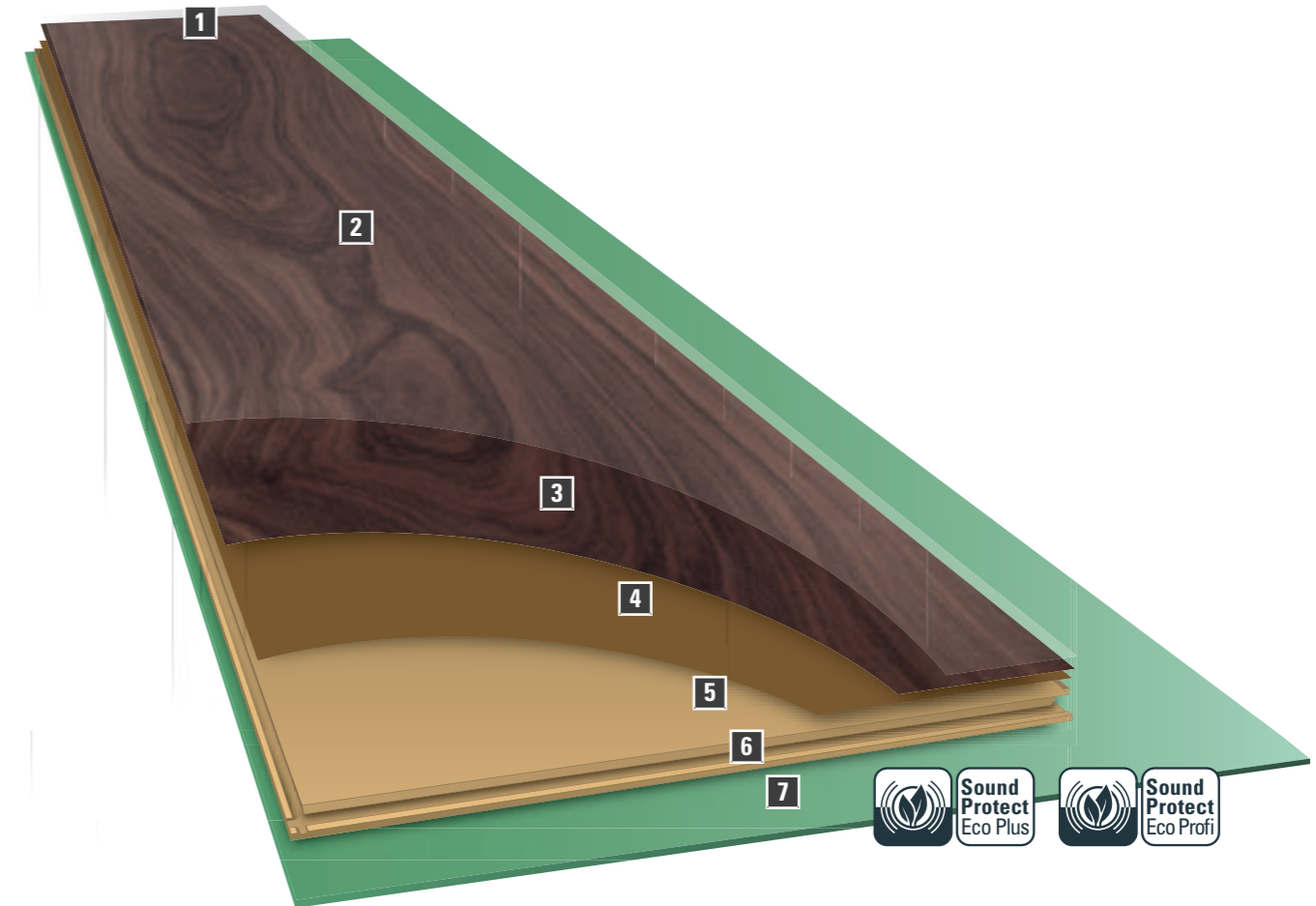

- 1 Waterproof edging**  
Water-repellent moisture protection
- 2 Surface**  
particularly hardwearing  
Melamine resin overlay
- 3 Decor paper**  
Melamine decor film
- 4 DPL+**  
Underlay, additionally resin-treated power film for the *piazza* and *piazza maxi* collections
- 5 Coreboard**  
Aqua-Protect®, HDF-Protect®, HDF board  
PEFC | FSC®-certified
- 6 Click installation**  
LocTec, the millionfold proven  
Unilin® installation system
- 7 Sound-Protect EcoPlus  
Sound-Protect Eco Profi**  
The optimal acoustic system from Witex is available either as a roll or pre-installed.





# My take-off and Landing strip

*„For me there is nothing nicer than snuggling in bed after a long day, losing myself in my dreams and making a new start in the morning well refreshed.“*

## bonita bonita V2

Practical, durable and varied. Entry-level collections from the bonita range create a zest for home living. And they come with all the important quality criteria of a wineo branded floor. The bonita collection, with its 20 select decors and the ability to be combined with each other, creates a special style, making the entry to the wineo laminate world exciting and creative. 8 select decors with an authentic groove design ensure a fabulous cottage flair.

- Select wood decors
- Additional protection due to edge protection
- Suitable for installation on underfloor heating | suitable for chair castors | non-staining
- 20 decors with optional mat – Perfect room acoustics due to the laminated Sound-Protect basic acoustic system
- 8 fabulous decors with an authentic floor-board look- can be installed with the Sound-Protect acoustic system supplied on a role!

# bonita

# bonita



**Maple cottage** | AH180B | AH180BC  
Single plank | Silk matt  
Skirting board 1: 30030103 | 4A18  
Skirting board 2: 30040109 | 7A18  
Skirting board 3: 30050125 | VA18



**Masuria apple tree** | AP120B | AP120BC  
Single plank | Silk matt  
Skirting board 1: 30030156 | 4A10  
Skirting board 2: 30040156 | 7A10  
Skirting board 3: 30050131 | VA10

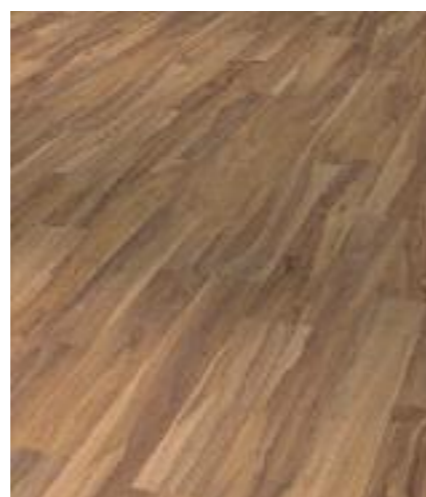

**Distinctive apple tree** | AP130B | AP130BC  
2-strip | Silk matt  
Skirting board 1: 30030157 | 4A19  
Skirting board 2: 30040157 | 7A19



**Western oak** | EI275B | EI275BC  
2-strip | Rough sawn  
Skirting board 1: 30030270 | 4E127  
Skirting board 2: 30040270 | 7E127  
Skirting board 3: 30050207 | VE127

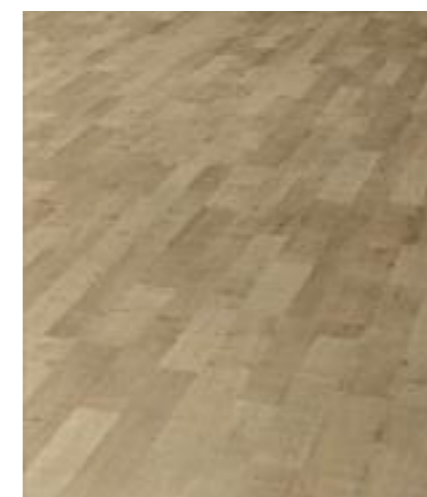

**Californian oak** | EI320B | EI320BC  
3-strip | Fine wooden pore  
Skirting board 1: 30030220 | 4E32  
Skirting board 2: 30040220 | 7E32



**White oak** | EI470B | EI470BC  
Single plank | Fine wooden pore  
Skirting board 1: 30030132 | 4E47  
Skirting board 2: 30040126 | 7E47  
Skirting board 3: 30050117 | VE47



**Beech royal** | BU200B | BU200BC  
3-strip | Fine wooden pore  
Skirting board 1: 30030107 | 4B13  
Skirting board 2: 30040113 | 7B13



**Rose beech** | BU370B | BU370BC  
2-strip | Fine wooden pore  
Skirting board 1: 30030215 | 4B37  
Skirting board 2: 30040215 | 7B37



**Old Lined oak** | EI150B | EI150BC  
2-strip | Fine wooden pore  
Skirting board 1: 30030133 | 4E50  
Skirting board 2: 30040136 | 7E50



**Almeria oak** | EI730B | EI730BC  
3-strip | Fine wooden pore  
Skirting board 1: 30030224 | 4E73  
Skirting board 2: 30040224 | 7E73



**Labrador oak** | EI840B | EI840BC  
Single plank | Fine wooden pore  
Skirting board 1: 30030235 | 4E84  
Skirting board 2: 30040235 | 7E84



**Spanish oak** | EI910B | EI910BC  
Single plank | Fine wooden pore  
Skirting board 1: 30030236 | 4E91  
Skirting board 2: 30040236 | 7E91





## Technical information

Decor surface:	1288 mm × 192 mm
Element thickness:	7 mm   9 mm (with acoustic system)
Coreboard:	HDF board (PEFC certified)
Resistance to abrasion:	AC 4 (EN 13329, Appendix E)
Installation:	Suitable for laying on underfloor heating
Room acoustics:	Perfect room acoustics through the Sound-Protect acoustic system (optional)

## Perfect fitting skirting boards are available.

Additional accessories on page 52.

Skirting board **1** 

Skirting board **2** 

Skirting board **3** 

# bonita

# bonita



**Alder romantic** | ER110B | ER110BC  
3-strip | Fine wooden pore  
Skirting board 1: 30030126 | 4E16  
Skirting board 2: 30040130 | 7E16  
Skirting board 3: 30050104 | VE16

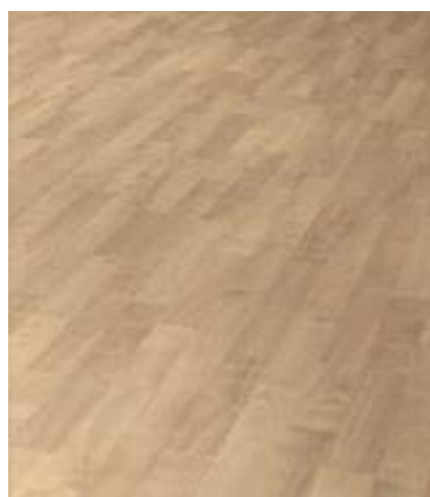

**Flemish cherry** | KB100B | KB100BC  
3-strip | Silk matt  
Skirting board 1: 30030239 | 4KB10  
Skirting board 2: 30040239 | 7KB10



**Tropical cherry** | KB140B | KB140BC  
3-strip | Fine wooden pore  
Skirting board 1: 30030139 | 4K14  
Skirting board 2: 30040142 | 7K14  
Skirting board 3: 30050108 | VK14



**Walnut style** | NU260B | NU260BC  
Butcher block | Fine wooden pore  
Skirting board 1: 30030145 | 4N45  
Skirting board 2: 30040148 | 7N45  
Skirting board 3: 30050116 | VN45

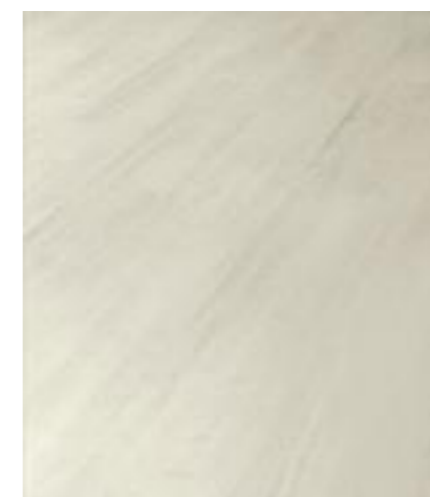

**Country pine** | PI240B | PI240BC  
Single plank | Fine wooden pore  
Skirting board 1: 30030193 | 4P24  
Skirting board 2: 30040193 | 7P24  
Skirting board 3: 30050120 | VP24



**Mountain pine** | KI100B | KI100BC  
Single plank | Silk matt  
Skirting board 1: 30030269 | 4K110  
Skirting board 2: 30040269 | 7K110  
Skirting board 3: 30050206 | VK110



**Austrian pine** | KI105B | KI105BC  
Single plank | Silk matt  
Skirting board 1: 30030274 | 4K1105  
Skirting board 2: 30040274 | 7K1105  
Skirting board 3: 30050211 | VK1105



**Walnut** | NU220B | NU220BC  
3-strip | Fine wooden pore  
Skirting board 1: 30030144 | 4N13  
Skirting board 2: 30040147 | 7N13  
Skirting board 3: 30050115 | VN13



## Technical information

Decor surface:	1288 mm × 192 mm
Element thickness:	7 mm   9 mm (with acoustic system)
Coreboard:	HDF board (PEFC certified)
Resistance to abrasion:	AC 4 (EN 13329, Appendix E)
Installation:	Suitable for laying on underfloor heating
Room acoustics:	Perfect room acoustics through the Sound-Protect acoustic system (optional)

# bonita

# bonita V2



**Swedish oak** | EI100BV2  
Single plank | Exclusive wood structure  
Skirting board 1: 30030217 | 4E110  
Skirting board 2: 30040217 | 7E110



**Swedish smoked oak** | EI110BV2  
Single plank | Exclusive wood structure  
Skirting board 1: 30030218 | 4E111  
Skirting board 2: 30040218 | 7E111



**Stained oak** | EI120BV2  
Single plank | Exclusive wood structure  
Skirting board 1: 30030219 | 4E112  
Skirting board 2: 30040219 | 7E112



**Ice oak** | EI960BV2  
Single plank | Exclusive wood structure  
Skirting board 1: 30030238 | 4E96  
Skirting board 2: 30040238 | 7E96



**American pecan** | PE100BV2  
Single plank | Exclusive wood structure  
Skirting board 1: 30030167 | 4P12  
Skirting board 2: 30040167 | 7P12



**Scottish oak** | EI255BV2  
Single plank | Silk matt  
Skirting board 1: 30030289 | 4E1255  
Skirting board 2: 30040289 | 7E1255  
Skirting board 3: 30050226 | VE1255



**Country oak** | EI330BV2  
Single plank | Silk matt  
Skirting board 1: 30030124 | 4E13  
Skirting board 2: 30040128 | 7E13  
Skirting board 3: 30050103 | VE13





**Yellowstone oak** | EI770BV2  
Single plank | Exclusive wood structure  
Skirting board 1: 30030228 | 4E77  
Skirting board 2: 30040228 | 7E77



## Technical information

Decor surface:	1380 mm x 192 mm
Element thickness:	7 mm
Coreboard:	HDF-Protect® (PEFC certified)
Resistance to abrasion:	AC 4 (EN 13329, Appendix E)
Installation:	Suitable for laying on underfloor heating

Skirting board **1** 

Skirting board **2** 

Skirting board **3** 

**Perfect fitting skirting boards are available.**  
Additional accessories on page 52.





# Our gourmet station

*„We all need a little help getting started in the morning. A fresh glass of juice and the first rays of sunshine always help. And sometimes we just simply sit together and enjoy that.“*

With its 12 solid decors and 4 individual finishes, the euro collection is placed among the entry-level qualities in the laminate sector. 24 classic and trendy decors provide something for every taste. And those who prefer the country style will certainly find what they are looking for in euro nature V2.

12 modern and trendy oak decors with individually matched surface textures, from classic colours through to modern shades of grey, you will find the latest colours here. European style!

- Additional protection due to edge protection
- Different surface textures – matched to the decor
- 12 decors with two-sided authentic joint (euro nature V2)
- Laminate panel suitable for damp areas due to Aqua-Protect system (euro nature V2)
- Perfect room acoustics due to the laminated Sound Protect Eco acoustic system (optional)

# euro

# euro actual



**Acacia** | AC610E | AC610EC  
Single plank | Exclusive wood structure  
Skirting board 1: 30030172 | 4AC61  
Skirting board 2: 30040173 | 7AC61  
Skirting board 3: 30050132 | VAC61



**Beech tradition** | BU320E | BU320EC  
2-strip | Matt surface  
Skirting board 1: 30030215 | 4B37  
Skirting board 2: 30040215 | 7B37  
Skirting board 3: 30050140 | VB37



**Oak structure** | EI310E | EI310EC  
Single plank | Matt surface  
Skirting board 1: 30030252 | 4EI31  
Skirting board 2: 30040252 | 7EI31  
Skirting board 3: 30050141 | VE31



**Walnut classic** | NU250E | NU250EC  
3-strip | Fine wooden pore  
Skirting board 1: 30030146 | 4N49  
Skirting board 2: 30040149 | 7N49  
Skirting board 3: 30050114 | VN49



**Walnut balance** | NU310E | NU310EC  
Single plank | Matt surface  
Skirting board 1: 30030257 | 4N31  
Skirting board 2: 30040257 | 7N31  
Skirting board 3: 30050144 | VN31



**Sardinian pine** | PI310E | PI310EC  
Single plank | Handscrapped I  
Skirting board 1: 30030248 | 4PI31  
Skirting board 2: 30040248 | 7PI31  
Skirting board 3: 30050145 | VPI31



**Country oak** | EI330E | EI330EC  
Single plank | Exclusive wood structure  
Skirting board 1: 30030124 | 4E13  
Skirting board 2: 30040128 | 7E13  
Skirting board 3: 30050103 | VE13



**Virginia oak** | EI920E | EI920EC  
Single plank | Handscrapped I  
Skirting board 1: 30030237 | 4E92  
Skirting board 2: 30040237 | 7E92  
Skirting board 3: 30050142 | VE92



**Trentino pine** | KI310E | KI310EC  
2-strip- | Exclusive wood structure  
Skirting board 1: 30030253 | 4KI31  
Skirting board 2: 30040253 | 7KI31  
Skirting board 3: 30050143 | VKI31



**Teak grey** | TE310E | TE310EC  
Single plank | Matt surface  
Skirting board 1: 30030256 | 4TE31  
Skirting board 2: 30040256 | 7TE31  
Skirting board 3: 30050146 | VTE31

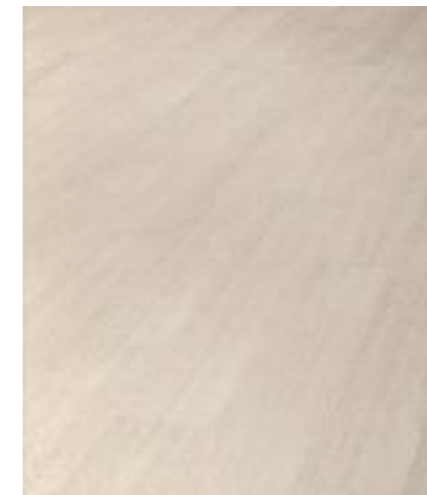

**Teak creme** | TE320E | TE320EC  
Single plank | Matt surface  
Skirting board 1: 30030255 | 4TE32  
Skirting board 2: 30040255 | 7TE32  
Skirting board 3: 30050147 | VTE32



**Teak dark** | TE610E | TE610EC  
Single plank | Matt surface  
Skirting board 1: 30030254 | 4TE61  
Skirting board 2: 30040254 | 7TE61  
Skirting board 3: 30050148 | VTE61

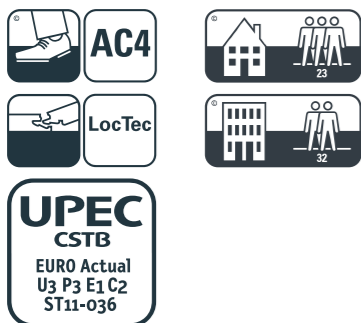



## Technical information

Decor surface:	1288 mm × 192 mm
Element thickness:	8 mm   10 mm (with acoustic system)
Coreboard:	HDF board (PEFC certified)
Resistance to abrasion:	AC 4 (EN 13329, Appendix E)
Installation:	Suitable for laying on underfloor heating
Room acoustics:	Perfect room acoustics through the Sound-Protect acoustic system (optional)

## Perfect fitting skirting boards are available.

Additional accessories on page 52.

Skirting board **1** 

Skirting board **2** 

Skirting board **3** 

# euro

# euro nature V2



**Oak Wave grey** | EI130EV2  
Single plank | Matt surface

Skirting board 1: 30030249 | 4E113  
Skirting board 2: 30040249 | 7E113  
Skirting board 3: 30050158 | VE113



**Yellow oak** | EI160EV2  
Single plank | Handscraped I

Skirting board 1: 30030128 | 4E25  
Skirting board 2: 30040132 | 7E25  
Skirting board 3: 30050130 | VE25



**European oak** | EI170EV2  
Single plank | Handscraped I

Skirting board 1: 30030245 | 4E17  
Skirting board 2: 30040245 | 7E17  
Skirting board 3: 30050149 | VE17



**Michigan oak** | EI370EV2  
Single plank | Handscraped I

Skirting board 1: 30030177 | 4E38  
Skirting board 2: 30040178 | 7E38  
Skirting board 3: 30050152 | VE38

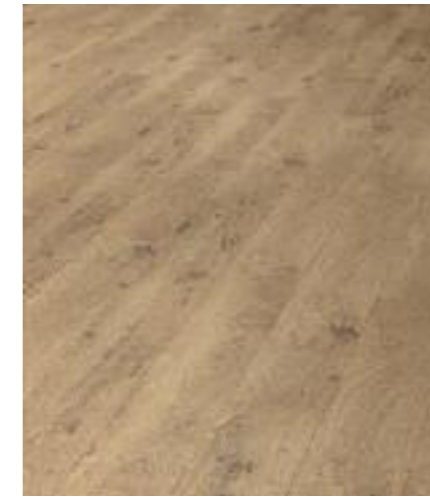

**Ontario oak** | EI375EV2  
Single plank | Handscraped I

Skirting board 1: 30030176 | 4E37  
Skirting board 2: 30040177 | 7E37  
Skirting board 3: 30050153 | VE37



**Oak Wave creme** | EI450EV2  
Single plank | Matt surface

Skirting board 1: 30030250 | 4E145  
Skirting board 2: 30040250 | 7E145  
Skirting board 3: 30050156 | VE145



**White washed oak** | EI250EV2  
Single plank | Handscraped I

Skirting board 1: 30030131 | 4E46  
Skirting board 2: 30040135 | 7E46  
Skirting board 3: 30050150 | VE46



**New Hampshire oak** | EI280EV2  
Single plank | Handscraped I

Skirting board 1: 30030246 | 4E128  
Skirting board 2: 30040246 | 7E128  
Skirting board 3: 30050151 | VE28



**Country oak** | EI330EV2  
Single plank | Handscraped I

Skirting board 1: 30030124 | 4E13  
Skirting board 2: 30040128 | 7E13  
Skirting board 3: 30050103 | VE13



**Oak Wave dark** | EI460EV2  
Single plank | Matt surface

Skirting board 1: 30030251 | 4E146  
Skirting board 2: 30040251 | 7E146  
Skirting board 3: 30050157 | VE146



**Oak** | EI560EV2  
Single plank | Handscraped I

Skirting board 1: 30030247 | 4E156  
Skirting board 2: 30040247 | 7E156  
Skirting board 3: 30050154 | VE156



**Sand oak** | EI675EV2  
Single plank | Handscraped I

Skirting board 1: 30030127 | 4E22  
Skirting board 2: 30040131 | 7E22  
Skirting board 3: 30050155 | VE22

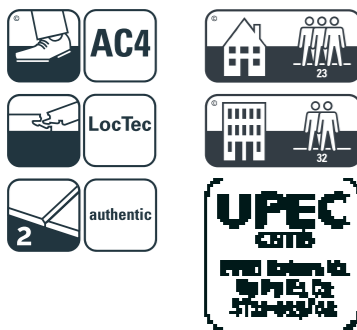



## Technical information

Decor surface:	1380 mm x 192 mm
Element thickness:	8 mm
Coreboard:	Aqua-Protect® (PEFC certified)
Resistance to abrasion:	AC 4 (EN 13329, Appendix E)
Installation:	Suitable for laying on underfloor heating

## Perfect fitting skirting boards are available.

Additional accessories on page 52.

Skirting board **1** 

Skirting board **2** 

Skirting board **3** 

# euro



# My wonderland

*„At home I like playing at being a princess best. Our hallway then turns into the royal room of mirrors: Mirror, mirror on the wall, who is the sweetest princess of all?“*

- Fabulous wood and stone decors
- Additional protection due to edge protection
- Authentic groove design
- Anti-static
- Laminate panel suitable for damp areas due to Aqua-Protect system
- Optionally available with laminated Sound Protect acoustic mat or can be installed with the Sound-Protect acoustic system supplied on a role
- Authentic finishes from rough sawn through to matt looks

**marena**  
**marena V2**  
**marena maxi V2**  
**marena XL V4**  
**marena stone V4**

Versatile in every respect. Customers will certainly find the right thing in the marena collection. This is not only guaranteed by the large choice of *marena* in the standard version, but also the other four collections by means of authentic V-joints, stone looks, extra long and extra wide planks. Includes something for everyone.. Wide range of features such as anti-static and the moisture-resistant coreboard thanks to the Aqua Protect system make these floors genuine carefree products!

See for yourself.

# marena

# marena



**Canadian mountain maple** | AH300M | AH300MC  
3-strip | Fine wooden pore  
Skirting board 1: 30030100 | 4A11  
Skirting board 2: 30040108 | 7A11  
Skirting board 3: 30050106 | VA11



**Noble maple** | AH360M | AH360MC  
Single plank | Silk matt  
Skirting board 1: 30030161 | 4A36  
Skirting board 2: 30040161 | 7A36



**Traditional apple** | AP100M | AP100MC  
2-strip | Fine wooden pore  
Skirting board 1: 30030102 | 4A17  
Skirting board 2: 30040110 | 7A17



**Japanese white oak** | EI700M | EI700MC  
2-strip | Silk matt  
Skirting board 1: 30030221 | 4E70  
Skirting board 2: 30040221 | 7E70  
Skirting board 3: 30050234 | VE70



**Mexican oak** | EI710M | EI710MC  
3-strip | Fine wooden pore  
Skirting board 1: 30030222 | 4E71  
Skirting board 2: 30040222 | 7E71



**Bergamo oak** | EI750M | EI750MC  
Single plank | Exclusive wood structure  
Skirting board 1: 30030226 | 4E75  
Skirting board 2: 30040226 | 7E75



**Reed bamboo** | BA120M | BA120MC  
feine Streifen | Silk matt  
Skirting board 1: 30030212 | 4BA12  
Skirting board 2: 30040212 | 7BA12



**Rustic beech** | BU270M | BU270MC  
2-strip | Fine wooden pore  
Skirting board 1: 30030111 | 4B23  
Skirting board 2: 30040116 | 7B23  
Skirting board 3: 30050102 | VB23



**Ocean beech** | BU300M | BU300MC  
3-strip | Fine wooden pore  
Skirting board 1: 30030108 | 4B17  
Skirting board 2: 30040114 | 7B17  
Skirting board 3: 30050101 | VB17



**Levantine oak** | EI760M | EI760MC  
Single plank | Exclusive wood structure  
Skirting board 1: 30030227 | 4E76  
Skirting board 2: 30040227 | 7E76



**Pin oak** | EI780M | EI780MC  
Single plank | Silk matt  
Skirting board 1: 30030229 | 4E78  
Skirting board 2: 30040229 | 7E78



**Oak ambience grey** | EI800M | EI800MC  
Single plank | Silk matt  
Skirting board 1: 30030231 | 4E80  
Skirting board 2: 30040231 | 7E80

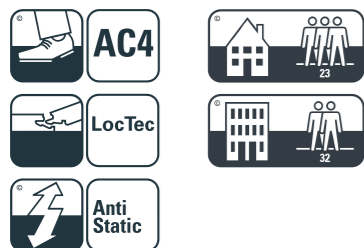



## Technical information

Decor surface:	1288 mm × 192 mm
Element thickness:	8 mm   10 mm (with acoustic system)
Coreboard:	Aqua-Protect® (PEFC certified)
Resistance to abrasion:	AC 4 (EN 13329, Appendix E)
Installation:	Suitable for laying on underfloor heating
Room acoustics:	Perfect room acoustics through the Sound-Protect acoustic system (optional)

## Perfect fitting skirting boards are available.

Additional accessories on page 52.

Skirting board **1** 

Skirting board **2** 

Skirting board **3** 

# marena

# marena



**Oak ambience creme** | EI820M | EI820MC  
Single plank | Silk matt  
Skirting board 1: 30030233 | 4E82  
Skirting board 2: 30040233 | 7E82



**Asturian oak** | EI830M | EI830MC  
Single plank | Silk matt  
Skirting board 1: 30030234 | 4E83  
Skirting board 2: 30040234 | 7E83



**Cornwell oak** | EI405M | EI405MC  
2-strip | Silk matt  
Skirting board 1: 30030184 | 4E48  
Skirting board 2: 30040184 | 7E48  
Skirting board 3: 30050233 | VE48



**Walnut country** | NU240M | NU240MC  
2-strip | Fine wooden pore  
Skirting board 1: 30030159 | 4E41  
Skirting board 2: 30040159 | 7E41



**Walnut classic** | NU250M | NU250MC  
3-strip | Fine wooden pore  
Skirting board 1: 30030146 | 4N49  
Skirting board 2: 30040149 | 7N49  
Skirting board 3: 30050114 | VN49



**American pecan** | PE100M | PE100MC  
Single plank | Exclusive wood structure  
Skirting board 1: 30030167 | 4P12  
Skirting board 2: 30040167 | 7P12



**Virginia oak** | EI920M | EI920MC  
Single plank | Exclusive wood structure  
Skirting board 1: 30030237 | 4E92  
Skirting board 2: 30040237 | 7E92  
Skirting board 3: 30050142 | VE92



**Cavan cherry** | KB310M | KB310MC  
Single plank | Silk matt  
Skirting board 1: 30030240 | 4K31  
Skirting board 2: 30040240 | 7K31



**Grey pine** | KI180M | KI180MC  
2-strip | Silk matt  
Skirting board 1: 30030140 | 4K15  
Skirting board 2: 30040145 | 7K15



**Toskanian pine** | PI100M | PI100MC  
2-strip | Silk matt  
Skirting board 1: 30030150 | 4P110  
Skirting board 2: 30040139 | 7P110



**Panga Panga** | PP300M | PP300MC  
2-strip | Exclusive wood structure  
Skirting board 1: 30030244 | 4PP30  
Skirting board 2: 30040244 | 7PP30



**African wengé** | WE100M | WE100MC  
2-strip | Exclusive wood structure  
Skirting board 1: 30030153 | 4W10  
Skirting board 2: 30040152 | 7W10  
Skirting board 3: 30050109 | VW10

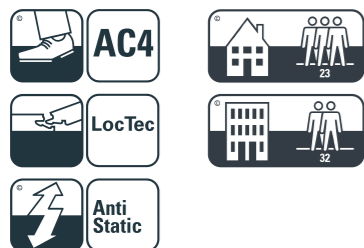



## Technical information

Decor surface:	1288 mm × 192 mm
Element thickness:	8 mm   10 mm (with acoustic system)
Coreboard:	Aqua-Protect® (PEFC certified)
Resistance to abrasion:	AC 4 (EN 13329, Appendix E)
Installation:	Suitable for laying on underfloor heating
Room acoustics:	Perfect room acoustics through the Sound-Protect acoustic system (optional)

## Perfect fitting skirting boards are available.

Additional accessories on page 52.

Skirting board **1** 

Skirting board **2** 

Skirting board **3** 

# marena

# marena V2



**Old castle oak** | EI105MV2  
Single plank | Registered embossed surface  
Skirting board 1: 30030282 | 4EI105  
Skirting board 2: 30040282 | 7EI105  
Skirting board 3: 30050219 | VEI105



**Oak champagne** | EI325MV2  
Single plank | Registered embossed surface  
Skirting board 1: 30030279 | 4EI325  
Skirting board 2: 30040279 | 7EI325  
Skirting board 3: 30050216 | VEI325



**Walnut oak** | EI335MV2  
Single plank | Registered embossed surface  
Skirting board 1: 30030280 | 4EI335  
Skirting board 2: 30040280 | 7EI335  
Skirting board 3: 30050217 | VEI335



**Tirol oak honey** | EI493MV2  
Single plank | Registered embossed surface  
Skirting board 1: 30030302 | 4EI493  
Skirting board 2: 30040322 | 7EI493



**Tirol oak mocha** | EI494MV2  
Single plank | Registered embossed surface  
Skirting board 1: 30030303 | 4EI494  
Skirting board 2: 30040323 | 7EI494



**Tirol oak silver** | EI496MV2  
Single plank | Registered embossed surface  
Skirting board 1: 30030304 | 4EI496  
Skirting board 2: 30040324 | 7EI496



**Silver grey oak** | EI390MV2  
Single plank | Registered embossed surface  
Skirting board 1: 30030283 | 4EI390  
Skirting board 2: 30040283 | 7EI390  
Skirting board 3: 30050220 | VEI390



**Tirol oak cream** | EI491MV2  
Single plank | Registered embossed surface  
Skirting board 1: 30030300 | 4EI491  
Skirting board 2: 30040320 | 7EI491



**Tirol oak bronze** | EI492MV2  
Single plank | Registered embossed surface  
Skirting board 1: 30030301 | 4EI492  
Skirting board 2: 30040321 | 7EI492



**Tirol oak anthracite** | EI497MV2  
Single plank | Registered embossed surface  
Skirting board 1: 30030305 | 4EI497  
Skirting board 2: 30040325 | 7EI497



**Tirol oak white** | EI498MV2  
Single plank | Registered embossed surface  
Skirting board 1: 30030306 | 4EI498  
Skirting board 2: 30040326 | 7EI498



**Tirol oak ochre** | EI499MV2  
Single plank | Registered embossed surface  
Skirting board 1: 30030288 | 4EI499  
Skirting board 2: 30040288 | 7EI499  
Skirting board 3: 30050225 | VEI499

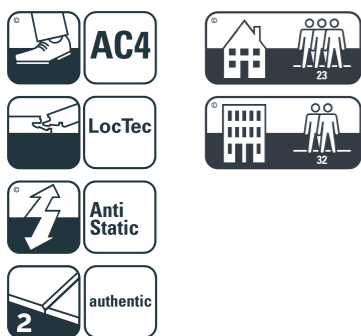



## Technical information

Decor surface:	1380 mm x 192 mm
Element thickness:	8 mm
Coreboard:	Aqua-Protect® (PEFC certified)
Resistance to abrasion:	AC 4 (EN 13329, Appendix E)
Installation:	Suitable for laying on underfloor heating

## Perfect fitting skirting boards are available.

Additional accessories on page 52.

Skirting board **1** 

Skirting board **2** 

Skirting board **3** 

# marena

# marena maxi V2



**Salt oak** | EI265MMV2  
Single plank | Silk matt

Skirting board 1: 30030276 | 4EI26  
Skirting board 2: 30040276 | 7EI26  
Skirting board 3: 30050213 | VEI26



**Natural castle oak** | EI305MMV2  
Single plank | Silk matt

Skirting board 1: 30030277 | 4EI30  
Skirting board 2: 30040277 | 7EI30  
Skirting board 3: 30050214 | VEI30



**Coastal oak** | EI315MMV2  
Single plank | Silk matt

Skirting board 1: 30030278 | 4EI315  
Skirting board 2: 30040278 | 7EI315  
Skirting board 3: 30050215 | VEI315



**Kahlua oak** | EI355MMV2  
Single plank | Silk matt

Skirting board 1: 30030131 | 4E46  
Skirting board 2: 30040135 | 7E46



**Michigan oak** | EI370MMV2  
Single plank | Silk matt

Skirting board 1: 30030177 | 4E38  
Skirting board 2: 30040178 | 7E38  
Skirting board 3: 30050152 | VE38



**Ontario oak** | EI375MMV2  
Single plank | Silk matt

Skirting board 1: 30030176 | 4E37  
Skirting board 2: 30040177 | 7E37  
Skirting board 3: 30050153 | VE37



**Oak champagne** | EI325MMV2  
Single plank | Registered embossed surface

Skirting board 1: 30030279 | 4EI325  
Skirting board 2: 30040279 | 7EI325  
Skirting board 3: 30050216 | VEI325



**Walnut oak** | EI335MMV2  
Single plank | Registered embossed surface

Skirting board 1: 30030280 | 4EI335  
Skirting board 2: 30040280 | 7EI335  
Skirting board 3: 30050217 | VEI335



**Dark Kahlua oak** | EI350MMV2  
Single plank | Silk matt

Skirting board 1: 30030178 | 4E39  
Skirting board 2: 30040179 | 7E39



**Alaska oak** | EI630MMV2  
Single plank | Silk matt

Skirting board 1: 30030275 | 4EI63  
Skirting board 2: 30040275 | 7EI63  
Skirting board 3: 30050212 | VEI63



**French walnut** | NU270MMV2  
Single plank | Silk matt

Skirting board 1: 30030166 | 4N27  
Skirting board 2: 30040166 | 7N27  
Skirting board 3: 30050113 | VN27



**Pecan exclusive** | PE480MMV2  
Single plank | Silk matt

Skirting board 1: 30030243 | 4PE48  
Skirting board 2: 30040243 | 7PE48

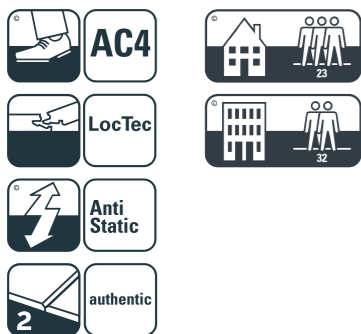



## Technical information

Decor surface:	1380 mm x 243 mm
Element thickness:	8 mm
Coreboard:	Aqua-Protect® (PEFC certified)
Resistance to abrasion:	AC 4 (EN 13329, Appendix E)
Installation:	Suitable for laying on underfloor heating

## Perfect fitting skirting boards are available.

Additional accessories on page 52.

Skirting board **1** 

Skirting board **2** 

Skirting board **3** 

# marena



# marena XL V4



**Columbian beech** | BU305MXLV4  
Single plank | Matt surface  
Skirting board 1: 30030268 | 4B30  
Skirting board 2: 30040268 | 7B30  
Skirting board 3: 30050214 | VB30



**Tennessee oak natural** | E1101MXLV4  
Single plank | Matt surface  
Skirting board 1: 30030308 | 4E1101  
Skirting board 2: 30040328 | 7E1101



**Tennessee oak white** | E1102MXLV4  
Single plank | Matt surface  
Skirting board 1: 30030309 | 4E1102  
Skirting board 2: 30040329 | 7E1102



**Tennessee oak platinum** | E1107MXLV4  
Single plank | Matt surface  
Skirting board 1: 30030314 | 4E1107  
Skirting board 2: 30040334 | 7E1107



**Tennessee oak smoked** | E1108MXLV4  
Single plank | Matt surface  
Skirting board 1: 30030312 | 4E1108  
Skirting board 2: 30040332 | 7E1108



**Canyon oak white** | E1235MXLV4  
Single plank | Matt surface  
Skirting board 1: 30030307 | 4E1235  
Skirting board 2: 30040327 | 7E1235



**Tennessee oak mocha** | E1103MXLV4  
Single plank | Matt surface  
Skirting board 1: 30030310 | 4E1103  
Skirting board 2: 30040330 | 7E1103



**Tennessee oak ochre** | E1104MXLV4  
Single plank | Matt surface  
Skirting board 1: 30030311 | 4E1104  
Skirting board 2: 30040331 | 7E1104



**Tennessee oak umbra** | E1106MXLV4  
Single plank | Matt surface  
Skirting board 1: 30030313 | 4E1106  
Skirting board 2: 30040333 | 7E1106



**Welsh oak** | E1465MXLV4  
Single plank | Rough sawn  
Skirting board 1: 30030285 | 4E1465  
Skirting board 2: 30040285 | 7E1465  
Skirting board 3: 30050222 | VE1465



**Oak Hacienda** | E1490MXLV4  
Single plank | Matt surface  
Skirting board 1: 30030185 | 4E149  
Skirting board 2: 30040185 | 7E149  
Skirting board 3: 30050119 | VE149



**Traditional oak** | E1920MXLV4  
Single plank | Rough sawn  
Skirting board 1: 30030237 | 4E92  
Skirting board 2: 30040237 | 7E92  
Skirting board 3: 30050142 | VE92

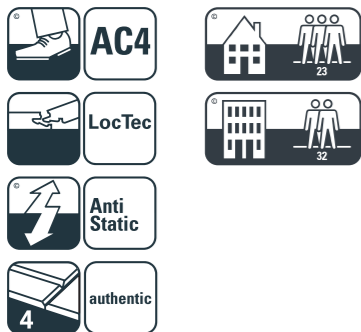



## Technical information

Decor surface:	1845 mm × 243 mm
Element thickness:	10 mm
Coreboard:	Aqua-Protect® (PEFC certified)
Resistance to abrasion:	AC 4 (EN 13329, Appendix E)
Installation:	Suitable for laying on underfloor heating

Perfect fitting skirting boards are available.

Additional accessories on page 52.

Skirting board **1** 

Skirting board **2** 

Skirting board **3** 

# marena

# marena stone V4



**Scratch Concrete** | P960MSV4  
Stone optics | Soft surface  
Skirting board 2: 30040335 | 7P960



**Travertine Creme** | P965MSV4  
Travertine | Soft surface  
Skirting board 2: 30040336 | 7P965



**Travertine mocca** | P970MSV4  
Travertine | Soft surface  
Skirting board 2: 30040337 | 7P970



**Black Slate** | S300MSV4  
Stone optics | Tile texture  
Skirting board 2: 30020535 | 7S300



**Concrete** | S310MSV4  
Stone optics | Soft surface  
Skirting board 2: 30020536 | 7S310

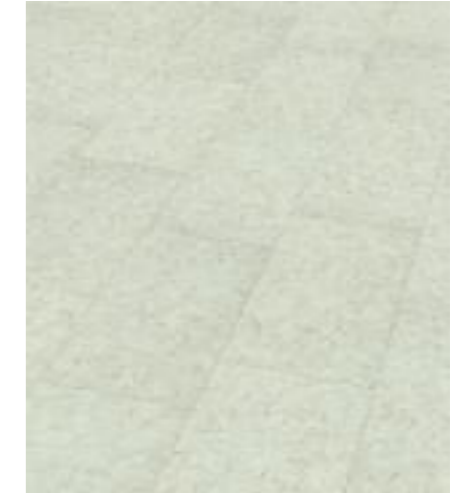

**Limestone** | S330MSV4  
Stone optics | Soft surface  
Skirting board 2: 30020538 | 7S330



**Creativ rost** | P975MSV4  
Metal optics | Soft surface  
Skirting board 2: 30040338 | 7P975



**Creative grey** | P980MSV4  
Metal optics | Soft surface  
Skirting board 2: 30040339 | 7P978



**Volcanic rock** | P985MSV4  
Stone optics | Soft surface  
Skirting board 2: 30040340 | P985



**Grey** | S370MSV4  
Stone optics | Soft surface  
Skirting board 2: 30020541 | 7S370



**Concrete light** | S390MSV4  
Stone optics | Soft surface  
Skirting board 2: 30020543 | 7S390



**Concrete dark** | S400MSV4  
Stone optics | Soft surface  
Skirting board 2: 30020544 | 7S400

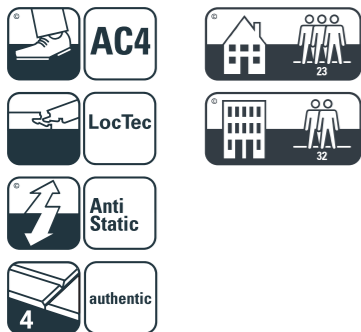

## Technical information

Decor surface:	596 mm × 305 mm
Element thickness:	8 mm
Coreboard:	Aqua-Protect® (PEFC certified)
Resistance to abrasion:	AC 4 (EN 13329, Appendix E)
Installation:	Suitable for laying on underfloor heating

Perfect fitting skirting boards are available.

Additional accessories on page 52.

Skirting board **2**



# marena



# My touch of luxury

*„When they have turned out well and I can enjoy them, in peace, with plenty of time – because chocolate makes you happy.“*

## ariosa

ariosa, the collection in the laminate range that gives you an appetite for more. With 8 fabulous decors in country style, including an authentic joint, this collection offers all the properties of a premium floor. The resilient and authentic surface, combined with the Aqua Protect coreboard suitable for damp areas, leaves nothing to be desired.

The 4-sided authentic joint gives the floor a solid character for all those who love real wood.

- Extra long laminate panel with four-sided authentic joint (V4)
- Surface textures matched to the wood decors – registered embossed
- Laminate panel suitable for damp areas due to Aqua-Protect system
- Can be installed with the Sound-Protect acoustic system supplied on a role!

# ariosa

# ariosa



**Oak cream** | EI020ARA  
Single plank | Registered embossed surface  
Skirting board 1: 30030258/4EI020ARA  
Skirting board 2: 30040258/7EI020ARA



**Snow oak** | EI030ARA  
Single plank | Registered embossed surface  
Skirting board 1: 30030259/4EI030ARA  
Skirting board 2: 30040259/7EI030ARA



**Oak espresso** | EI050ARA  
Single plank | Registered embossed surface  
Skirting board 1: 30030260/4EI050ARA  
Skirting board 2: 30040260/7EI050ARA



**Oak nutmeg** | EI090ARA  
Single plank | Registered embossed surface  
Skirting board 1: 30030264/4EI090ARA  
Skirting board 2: 30040264/7EI090ARA



**Wenge cocoa** | WE010ARA  
Single plank | Exclusive wood structure  
Skirting board 1: 30030265/4WE010ARA  
Skirting board 2: 30040265/7WE010ARA



**Oak slate** | EI060ARA  
Single plank | Registered embossed surface  
Skirting board 1: 30030261/4EI060ARA  
Skirting board 2: 30040261/7EI060ARA



**Cinnamon oak** | EI070ARA  
Single plank | Registered embossed surface  
Skirting board 1: 30030262/4EI070ARA  
Skirting board 2: 30040262/7EI070ARA



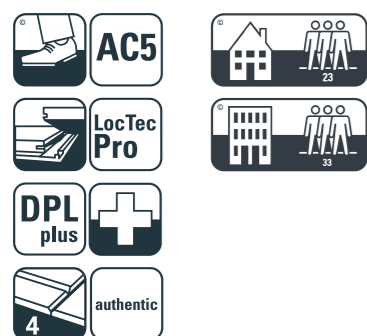

**Oak vanilla** | EI080ARA  
Single plank | Registered embossed surface  
Skirting board 1: 30030263/4EI080ARA  
Skirting board 2: 30040263/7EI080ARA



## Technical information

Decor surface:	1845 mm × 188 mm
Element thickness:	12 mm
Coreboard:	Aqua-Protect® (PEFC certified)
Resistance to abrasion:	AC 5 (EN 13329, Appendix E)
Installation:	Suitable for laying on underfloor heating

Skirting board **1** 

Skirting board **2** 

Perfect fitting skirting boards are available.  
Additional accessories on page 52.

# ariosa



## My chill-out zone

*„The most precious thing for me:  
lounging on the sofa, chasing after  
daydreams or forgetting everything  
else around me whilst reading a  
gripping thriller.“*

### piazza piazza maxi

No compromise on quality, design and ecology. The wineo floors piazza and piazza maxi are a collection of technically feasible properties. For example, DPL+ ensures the best results in terms of resistance, and the use of the FSC®-certified Aqua-Protect coreboard even makes these floors suitable for machine cleaning and damp areas. Using FSC®-certified materials in conjunction with the Sound-Protect-Eco acoustic system means that these collections are surely the most sustainable in the laminate flooring sector at the moment.

- High quality, exclusive wood decors in both standard and wide formats
- Ecological laminate flooring due to FSC® coreboard with the *Blue Angel* award
- Extra impact-resistant surface due to DPL+ | Suitable for machine cleaning\*
- Laminate panel suitable for damp areas due to Aqua-Protect system
- Perfect room acoustics due to the laminated Sound Protect Eco Plus acoustic system or can be installed with the Sound-Protect acoustic system supplied on a role!

# piazza

# piazza



**African afzelia** | AF100P | AF100PC  
2-strip | Matt surface

Skirting board 1: 30030165 | 4K21  
Skirting board 2: 30040165 | 7K21  
Skirting board 3: 30050232 | VK21



**Argentinean maple** | AH315P | AH315PC  
3-strip | Rough sawn

Skirting board 1: 30030272 | 4A31  
Skirting board 2: 30040272 | 7A31  
Skirting board 3: 30050209 | VA31



**Columbian beech** | BU305P | BU305PC  
Single plank | Matt surface

Skirting board 1: 30030268 | 4B30  
Skirting board 2: 30040268 | 7B30  
Skirting board 3: 30050214 | VB30

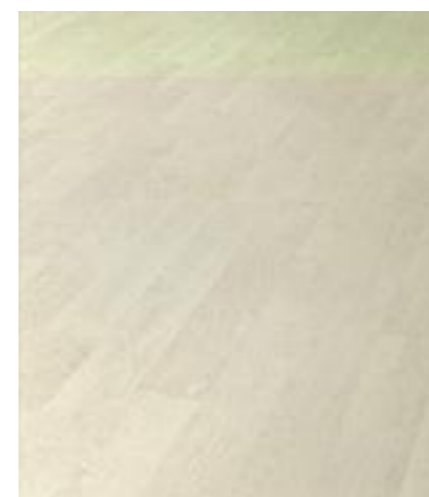

**White oak** | EI410P | EI410PC  
2-strip | Matt surface

Skirting board 1: 30030185 | 4E49  
Skirting board 2: 30040185 | 7E49  
Skirting board 3: 30050119 | VE49



**Light burlington oak** | EI420P | EI420PC  
Single plank 1 + 2-strip | Matt surface

Skirting board 1: 30030187 | 4E52  
Skirting board 2: 30040187 | 7E52



**Oak wave creme** | EI450P | EI450PC  
Single plank | Matt surface

Skirting board 1: 30030250 | 4E145  
Skirting board 2: 30040250 | 7E145  
Skirting board 3: 30050156 | VE145



**Oak wave grey** | EI130P | EI130PC  
Single plank | Matt surface

Skirting board 1: 30030249 | 4E113  
Skirting board 2: 30040249 | 7E113  
Skirting board 3: 30050158 | VE113



**Salt oak** | EI265P | EI265PC  
Single plank | Rough sawn

Skirting board 1: 30030276 | 4E126  
Skirting board 2: 30040276 | 7E126  
Skirting board 3: 30050213 | VE126



**Coastal oak** | EI315P | EI315PC  
Single plank | Rough sawn

Skirting board 1: 30030278 | 4E1315  
Skirting board 2: 30040278 | 7E1315  
Skirting board 3: 30050215 | VE1315



**Classic oak** | EI635P | EI635PC  
2-strip | Matt surface

Skirting board 1: 30030123 | 4E10  
Skirting board 2: 30040127 | 7E10



**Nordic oak** | EI665P | EI665PC  
Single plank | Matt surface

Skirting board 1: 30030271 | 4E166  
Skirting board 2: 30040271 | 7E166  
Skirting board 3: 30050208 | VE166



**Walnut anthracite** | NU300P | NU300PC  
2-strip | Matt surface

Skirting board 1: 30030273 | 4NU30  
Skirting board 2: 30040273 | 7NU30  
Skirting board 3: 30050210 | VNU30





## Technical information

Decor surface:	1288 mm × 192 mm
Element thickness:	8 mm   10 mm (with acoustic system)
Coreboard:	Aqua-Protect® (FSC® certified)
Resistance to abrasion:	AC 5 (EN 13329, Appendix E)
Installation:	Suitable for laying on underfloor heating
Room acoustics:	Perfect room acoustics through the Sound-Protect acoustic system (optional)

## Perfect fitting skirting boards are available.

Additional accessories on page 52.

Skirting board **1** 

Skirting board **2** 

Skirting board **3** 

# piazza

# piazza maxi



**Portuguese oak** | E1430PM  
Single plank | Matt surface  
Skirting board 1: 30030189 | 4E43  
Skirting board 2: 30040189 | 7E43



**Bog oak** | E1435PM  
Single plank | Matt surface  
Skirting board 1: 30030190 | 4E54  
Skirting board 2: 30040190 | 7E54



**Welsh pale oak** | E1445PM  
Single plank | Rough sawn  
Skirting board 1: 30030284 | 4E1445  
Skirting board 2: 30040284 | 7E1445  
Skirting board 3: 30050221 | VE1445



**Tirol oak cream** | E1491PM  
Single plank | Rough sawn  
Skirting board 1: 30030300 | 4E1491  
Skirting board 2: 30040320 | 7E1491



**Tirol oak honey** | E1493PM  
Single plank | Rough sawn  
Skirting board 1: 30030302 | 4E1493  
Skirting board 2: 30040322 | 7E1493



**Tirol oak** | E1495PM  
Single plank | Rough sawn  
Skirting board 1: 30030288 | 4E149  
Skirting board 2: 30040288 | 7E149  
Skirting board 3: 30050225 | VE149



**Welsh dark oak** | E1465PM  
Single plank | Matt surface  
Skirting board 1: 30030285 | 4E1465  
Skirting board 2: 30040285 | 7E1465  
Skirting board 3: 30050222 | VE1465



**Ocean oak** | E1475PM  
Single plank | Matt surface  
Skirting board 1: 30030286 | 4E147  
Skirting board 2: 30040286 | 7E147  
Skirting board 3: 30050223 | VE147



**Volcano oak** | E1485PM  
Single plank | Matt surface  
Skirting board 1: 30030287 | 4E148  
Skirting board 2: 30040287 | 7E148  
Skirting board 3: 30050224 | VE148



**Tirol oak silver** | E1496PM  
Single plank | Rough sawn  
Skirting board 1: 30030304 | 4E1496  
Skirting board 2: 30040324 | 7E1496



**Tirol oak white** | E1498PM  
Single plank | Rough sawn  
Skirting board 1: 30030306 | 4E1498  
Skirting board 2: 30040325 | 7E1498



**Alaska oak** | E1630PM  
Single plank | Matt surface  
Skirting board 1: 30030275 | 4E163  
Skirting board 2: 30040275 | 7E163  
Skirting board 3: 30050212 | VE163

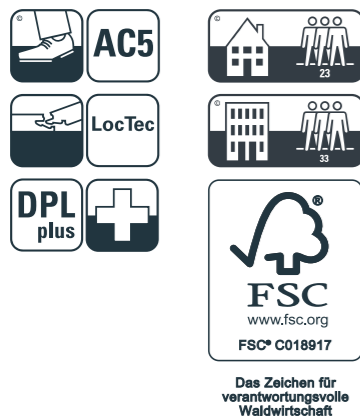



## Technical information

Decor surface:	1380 mm x 243 mm
Element thickness:	10 mm
Coreboard:	Aqua-Protect® (FSC® certified)
Resistance to abrasion:	AC 5 (EN 13329, Appendix E)
Installation:	Suitable for laying on underfloor heating

Perfect fitting skirting boards are available.

Additional accessories on page 52.

Skirting board **1** 

Skirting board **2** 

Skirting board **3** 

# piazza



# My Bakery

*„I have really earned this sweet time-out! After all, every master baker should also test why she has slaved away baking in the kitchen for half the day.“*

- Classic plain colours, stone decors and creative decors with matt and high gloss finish
- 8 mm thick laminate panel suitable for damp areas due to Aqua-Protect system
- All-round micro-bevel
- Resilient surface hardened by electron beams
- Can be installed with the Sound-Protect acoustic system supplied on a role!

## color

For those who like it especially refined: color turns rooms into experiences, in a choice of shiny or matt. Its selection of plain decors offers free scope to creative ideas.

Stone decors and also creative decors give the color collection a special place in the laminate sector.

# color



# color matt



**White** | CHC500CM  
Matt surface  
Skirting board 4: 30040342



**Black** | CHC510CM  
Matt surface  
Skirting board 4: 30040344



**Umbra grey** | CHC530CM  
Matt surface  
Skirting board 4: 30040346

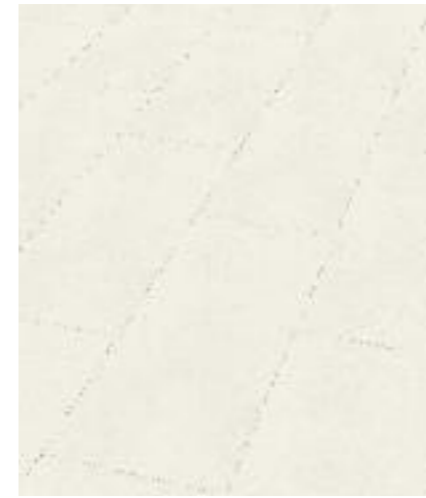

**Linen** | CHC560CM  
Matt surface



**Wenge original** | CHC650CM  
Matt surface  
Skirting board 4: 30040355



**Raw Steel** | CHC660CM  
Matt surface  
Skirting board 4: 30040356



**Ruby red** | CHC540CM  
Matt surface



**Saphire blue** | CHC550CM  
Matt surface



**Bone** | CHC670CM  
Matt surface  
Skirting board 4: 30040357



## Technical information

Decor surface:	853 mm × 329 mm
Element thickness:	8 mm
Coreboard:	Aqua-Protect® (PEFC certified)
Resistance to abrasion:	AC 4 (EN 13329, Appendix E)
Installation:	Suitable for laying on underfloor heating

Perfect fitting skirting boards are available.  
Additional accessories on page 52.

Skirting board **4**



# color

# color high gloss



**White** | CHC500CH  
High gloss surface  
Skirting board 4: 30040341



**Black** | CHC510CH  
High gloss surface  
Skirting board 4: 30040343



**Umbr grey** | CHC530CH  
High gloss surface  
Skirting board 4: 30040345

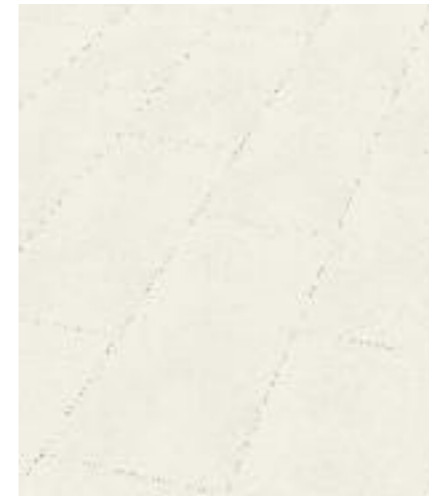

**Linen** | CHC560CH  
High gloss surface



**Carrara Marble** | CHC570CH  
High gloss surface  
Skirting board 4: 30040352

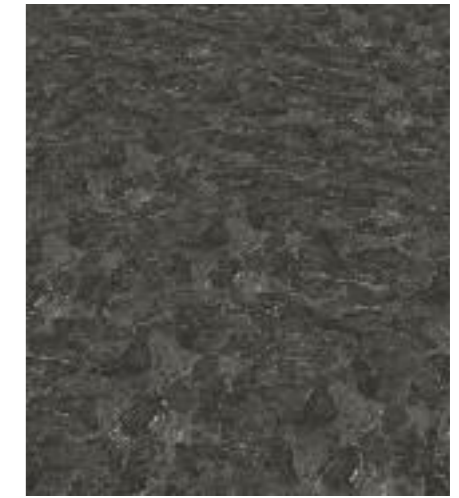

**Asiatic Marble** | CHC580CH  
High gloss surface  
Skirting board 4: 30040353



**Ruby red** | CHC540CH  
High gloss surface



**Saphire blue** | CHC550CH  
High gloss surface



**Travertine Creme** | CHC590CH  
High gloss surface  
Skirting board 4: 30040354



## Technical information

Decor surface:	853 mm × 329 mm
Element thickness:	8 mm
Coreboard:	Aqua-Protect® (PEFC certified)
Resistance to abrasion:	WR 3 (EN 14354, Anhang D)
Installation:	Suitable for laying on underfloor heating

Perfect fitting skirting boards are available.  
Additional accessories on page 52.

Skirting board **4**



# color

# SKIRTING BOARDS WOOD OPTICS

The perfect finish. The right accessories are all part of a wineo branded floor.

Not only do these provide the optimum finish in terms of looks, but they also ensure what is required for a long product life – because the wineo branded accessories have been especially matched to the floors. You will therefore find the matching skirting boards and transition profiles for each product. The Sound-Protect Eco Plus acoustic system made of 95% natural raw materials with outstanding insulating properties deserves a special mention.



**Clipstar fastening system**  
50 clips/set (25 sets/carton)  
for approx. 25 running m. of  
wineo skirting board 30020239



**Skirting board 22/42**  
MDF support | 22 mm × 42 mm × 2400 mm  
Selling Unit: 4 pieces



**Skirting board 14/70**  
MDF support | 14 mm × 70 mm × 2400 mm  
Selling Unit: 4 pieces



**Skirting board 14/19**  
MDF support | 14 mm × 19 mm × 2400 mm  
Selling Unit: 20 pieces



**Skirting board 18/78**  
MDF support | 18 mm × 78 mm × 2400 mm  
Selling Unit: 4 pieces

## Skirting boards + Clipstar

For every wineo floor there is the perfectly matching skirting board for a harmonic wallfinish, also as paintable versions. Fit skirting boards quickly and invisibly with the wineo Clipstar fastening system. This also enables the skirting board to be easily removed – a great advantage when painting or wallpapering.

**Skirting board white 22/42** | 30030195

**Skirting board white 14/70** | 30040208

**Skirting board white 14/19** | 30050121

# EXCLUSIVE SKIRTING BOARDS INDIVIDUALLY



Polar white | matt | 30060345



Aluminium brushed | matt | 30060360



Stainless steel look | matt | 30060361



White | 30040342

30040341



Black | 30040344

30040343



Umbra grey | 30040346

30040345



Wenge Original | 30040355



Raw steel | 30040356



Bone | 30040357



Carrara Marble | 30040352



Asiatic Marble | 30040353



Travertine Creme | 30040354

# ALUMINIUM PROFILES WOOD- AND METALLOPTIC



wineo profiles are ideally suited for perfect colour and visual transitions between floorings and walls, adjoining doorways or other structures.

Apart from the classic flooring profiles made of aluminium, wineo also offers attractive wood optics alternatives for all closures and transitions. The necessary expansion joint is also taken into account.

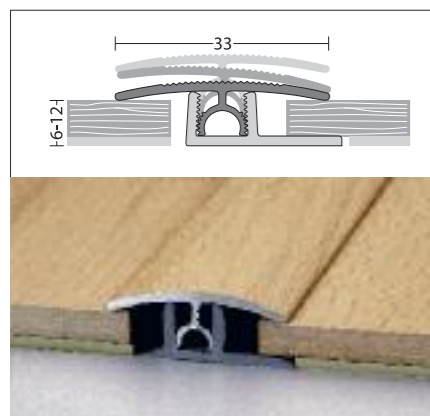

**Profitec Junior transition profile**  
Two-part aluminium profile for covering expansion joints.  
**For floor thicknesses of 6 – 12 mm**  
33 mm x 1 m | 2,7m  
Packing Unit: 10 pieces/Box  
Selling Unit: 1 piece

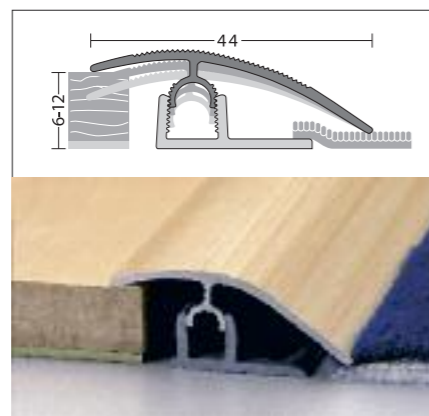

**Profitec Junior adaptation profile**  
Two-part aluminium profile for transitions between floors of varying heights  
**For floor thicknesses of 6 – 12 mm**  
44 mm x 1 m | 2,7m  
Packing Unit: 10 pieces/Box  
Selling Unit: 1 piece

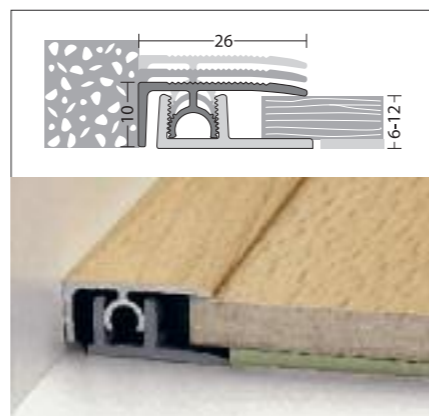

**Profitec Junior end profile**  
Two-part aluminium profile, e.g. for transitions between floors and walls.  
**For floor thicknesses of 6 – 12 mm**  
26 mm x 1 m | 2,7m  
Packing Unit: 10 pieces/Box  
Selling Unit: 1 piece

1 m	2,7 m	1 m	2,7 m	1 m	2,7 m
48100449	48100425	48100457	48100433	48100465	48100441   Silver
48100448	48100424	48100456	48100432	48100464	48100440   Sand
48100450	48100426	48100458	48100434	48100466	48100442   Steel matt
48100453	48100429	48100461	48100437	48100469	48100445   Maple
48100451	48100427	48100459	48100435	48100467	48100443   Beech
48100452	48100428	48100460	48100436	48100468	48100444   Light Oak
48100454	48100430	48100462	48100438	48100470	48100446   Cherry
48100455	48100431	48100463	48100439	48100471	48100447   Walnut

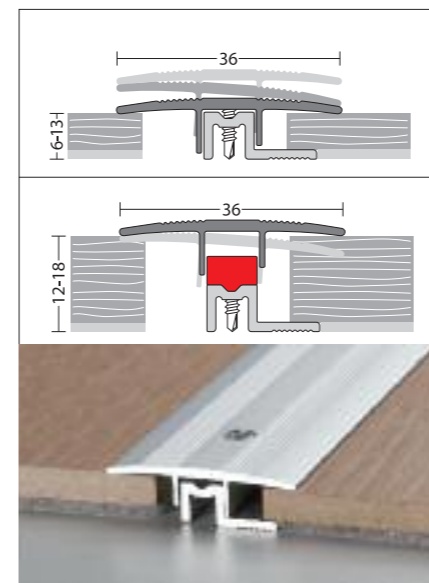

**Transition profile PS400PEP**  
Screwed two-part aluminium profile for covering expansion joints.  
**For floor thicknesses of 6–13 mm**  
36 mm x 1 m | 2,7m  
Packing Unit: 10 pieces/Box  
Selling Unit: 1 piece

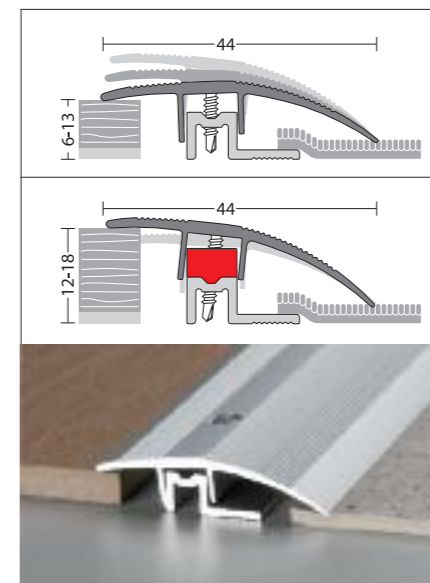

**Adaptation profile PS400PEP**  
Screwed two-part aluminium profile for transitions between floors of varying heights.  
**For floor thicknesses of 6–13 mm**  
44 mm x 1 m | 2,7m  
Packing Unit: 10 pieces/Box  
Selling Unit: 1 piece

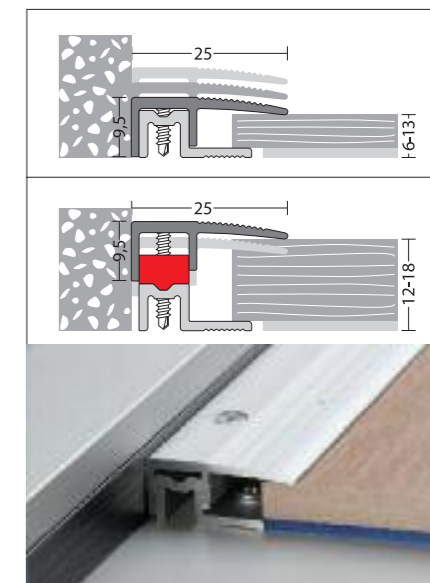

**End profile PS400PEP**  
Screwed two-part aluminium profile, e.g. for transitions between floors and walls.  
**For floor thicknesses of 6–13 mm.**  
25 mm x 1 m | 2,7 m  
Packing Unit: 10 pieces/Box  
Selling Unit: 1 piece

1 m	2,7 m	1 m	2,7 m	1 m	2,7 m
48100413	48100401	48100417	48100405	48100421	48100409   Silver
48100412	48100400	48100416	48100404	48100420	48100408   Sand
48100414	48100402	48100418	48100406	48100422	48100410   Steel matt
48100415	48100403	48100419	48100407	48100423	48100411   Steel polished

**Increase block**  
Sand | Stainless steel matt | 48100502

**Increase block**  
Silver | Stainless steel polished | 48100503

# UNDERLAY MATERIAL THE PERFECT SOLUTION

For every wineo floor and every room situation there is the perfect underlay material.

Footfall noise insulation for underfloor heating, footfall noise insulation with integrated vapour barrier, insulating boards to improve walking comfort and to compensate for height differences, underlays with insulating properties and vapour barrier combined or underlays for optimal footfall noise insulation – the perfect solution for every application.



wineo-insulation board  
Sound Protect Eco Plus

- Permanently elastic underlay material made from 90% natural raw materials
- Non woven polyester on one side
- Integrated vapour barrier through gluing the stair nosings with combination sealing tape
- Good room sound properties
- Ideal for use with under-floor heating

Footfall noise reduction: > 19 dB  
Loudness reduction: about 28 %  
Thermal resistance: 0,01 m<sup>2</sup>/kW  
**Thickness 2 mm | Width 1 m | Length 7 m**

Art. No. 10020211  
Packing Unit: 40 Rolls/Pallet  
Selling Unit: 1 Roll/7 m<sup>2</sup>



wineo-insulation board  
Sound Protect Eco Profi

- Permanently elastic underlay material made from 90% natural raw materials
- Non woven polyester on one side
- Integrated vapour barrier through gluing the stair nosings with combination sealing tape
- Good room sound properties
- Ideal for use with under-floor heating

Footfall noise reduction: > 20 dB  
Loudness reduction: about 31 %  
Thermal resistance: 0,01 m<sup>2</sup>/kW  
**Thickness 2,8 mm | Width 1 m | Length 5 m**

Art. No. 10020212  
Packing Unit: 40 Rolls/Pallet  
Selling Unit: 1 Roll/5 m<sup>2</sup>



wineo-insulation board  
Sound-Protect Eco Plus S/D

- Permanently elastic underlay material made from 90% natural raw materials
- Aluminium laminated on one side
- Even better integrated moisture barrier through gluing the stair nosings with combination sealing tape
- Good room sound properties
- Usable with under-floor heating

Footfall noise reduction: > 19 dB  
Loudness reduction: about 28 %  
Thermal resistance: 0,01 m<sup>2</sup>/kW  
**Thickness 2 mm | Width 1 m | Length 8 m**

Art. No. 10020220  
Packing Unit: 40 Rolls/Pallet  
Selling Unit: 1 Roll/8 m<sup>2</sup>



wineo-insulation board  
Sound Protect Eco Profi S/D

- Permanently elastic underlay material made from 90% natural raw materials
- Aluminium laminated on one side
- Even better integrated moisture barrier through gluing the stair nosings with combination sealing tape
- Good room sound properties
- Usable with under-floor heating

Footfall noise reduction: > 20 dB  
Loudness reduction: about 31 %  
Thermal resistance: 0,01 m<sup>2</sup>/kW  
**Thickness 3 mm | Width 1 m | Length 5,5 m**

Art. No. 10020221  
Packing Unit: 40 Rolls/Pallet  
Selling Unit: 1 Roll/5,5 m<sup>2</sup>



wineo-Combi-Mat  
Polystyrene insulation material, aluminium laminated

- Quality underlay with excellent insulation characteristics
- Combined with an effective vapour barrier
- User-friendly and quick to install
- Environmentally friendly, as free of FCFC
- Not suitable for laying on underfloor heating!

Footfall noise reduction: > 18 dB  
**Thickness 3 mm | Width 1 m | Length 15 m**

Art.-Nr. 10020605  
Packing Unit: 15 Rolls/Pallet  
Selling Unit: 1 Roll/15m<sup>2</sup>

Footfall noise reduction: > 18 dB  
**Thickness 3 mm | Width 1,2 m | Length 25 m**

Art. No. 10020600  
Packing Unit: 11 Rolls/Pallet  
Selling Unit: 1 Roll/30 m



wineo-insulation board

- FSC® certified | natureplus® seal
- Improves the walking comfort | reduces the footfall
- Enables a height compensation of up to approx. 3 mm
- Good heat insulation
- Not optimal for laying on underfloor heating

Footfall noise reduction: ≥ 19 dB  
Thermal resistance: 0,07 m<sup>2</sup>/kW  
**Thickness 5 mm | Width 0,59 m | Length 0,79 m**

Art. No. 10020201  
Packing Unit: 20 packs/pallet  
Selling Unit: 1 pack/10,25 m<sup>2</sup>

# UNDERLAY MATERIAL THE PERFECT SOLUTION



**Combined foil**

- Good footfall insulation for all hard floor coverings
- A combination of unlinked polyethylene foam and a special
- Diffufol® foil for the reduction of water vapour diffusion
- with a vapour barrier function
- Not suitable for laying on underfloor heating!

Footfall noise reduction:  $\geq 18$  dB  
**Thickness 2 mm | Width 1 m | Length 25m**

Art.-Nr. 10020107  
 Packing Unit: 4 Rolls/Bag  
 Selling Unit: 1 Roll/25m<sup>2</sup>



**PE vapour barrier**

- Thin PE foil.
- As a separating layer between the floor screed and the insulating underlay under all types of hard floor coverings
- The PE vapour barrier has the same technical specification as the 0.2mm-thick PE foil
- With wooden subfloors, the PE vapour barrier is not absolutely necessary

**Thickness 0,125 mm | Width 1 m | Length 30 m**

Art. No. 10100015  
 Packing Unit: 100 Rolls/Pallet  
 Selling Unit: 1 Roll/30m<sup>2</sup>

**Thickness 0,125 mm | Width 4 m | Length 25 m**

Art.-Nr. 10100016  
 Packing Unit: 20 Rolls/Pallet  
 Selling Unit: 1 Roll/100m<sup>2</sup>



**PE underlay foam**

- Underlay foam designed to improve walking comfort
- Not suitable for use as a vapour barrier or for laying on underfloor heating!

Footfall noise reduction:  
 $\geq 14$  dB – 2mm PE underlay foam  
**Thickness 2mm | Width 1m | Length 25m**

Art.-Nr. 10020106  
 Packing Unit: 5 Rolls/Bag  
 Selling Unit: 1 Roll/25m<sup>2</sup>

Footfall noise reduction:  
 $\geq 18$  dB – 3mm Envoy Basic  
**Thickness 3 mm | Width 1 m | Length 25 m**

Art.-Nr. 10020110  
 Packing Unit: 4 Rolls/Bag  
 Selling Unit: 1 Roll/25m<sup>2</sup>



# SERVICE WE'RE HERE TO HELP

## Our guarantees

Our floors have been developed for a long product life. And because only tested quality leaves our factory, we have come up with something special in our guarantee statement: a lifetime guarantee on product stability and the Click connection for all wineo laminate floors. On the *piazza* and *piazza maxi* collections there is even a 5-fold lifelong guarantee on product stability, click-in connection, abrasion, UV-resistance and resistance to stains. Registration for the lifetime guarantee is possible using either the guarantee card (obtainable from a specialist retailer) or the Internet. The guarantee conditions can be found on the guarantee card or on our website.

[www.witex.com/garantie](http://www.witex.com/garantie)

## Delivery

Your satisfaction is our goal. Therefore, all products are available ex stock, and thus as soon as possible at your site. Trust us!

## Visit us on the Internet too

You will find all the information about us and our brands at [www.wineo.de](http://www.wineo.de). From the product portfolio through to new product features and technical information, our Internet platform provides everything you are looking for.

Also take the opportunity on [www.witex.com](http://www.witex.com) to show the laminate floors in an installed situation. Decide on your room and install the floor there as easy as anything.

## Your local contact

If you are interested in our floors or have any further questions, then our local retail partner is happy to be of help. Under [www.witex.com](http://www.witex.com) or [www.windmoeller-flooring.com](http://www.windmoeller-flooring.com), you can quickly and easily find your local partner with the help of our dealer search. Simply enter your postcode and away you go!



windmüller flooring products GmbH

Nord-West-Ring 21

32832 Augustdorf

Tel.: +49 (0) 5237 609 - 0

Fax: +49 (0) 5237 609 - 309

Mail: [info@wineo.de](mailto:info@wineo.de)

[www.wineo.de](http://www.wineo.de)

Stage of life

wineo®